



ILUSTRÍSSIMO(A) SENHOR(A) PREGOEIRO(A) DA CÂMARA MUNICIPAL DE VOTUPORANGA – SP

Ref.: Pregão Eletrônico nº 02/2026

Processo Administrativo nº 37/2026

Objeto: Aquisição de equipamentos de informática.

49.608.894 Arthur Davanço Moretto, inscrita no CNPJ sob o nº 49.608.894/0001-96, já devidamente qualificada no certame em epígrafe, vem, tempestivamente, com fulcro no art. 165, §5º da Lei Federal nº 14.133/2021 e no item 8.7 do Edital, apresentar **CONTRARRAZÕES AO RECURSO ADMINISTRATIVO** interposto pela empresa **F.C.LOPES INFORMÁTICA LTDA-ME**, pelas razões de fato e de direito a seguir expostas.

1. DA TEMPESTIVIDADE

O prazo para apresentação de contrarrazões é de 3 (três) dias úteis, contados da interposição do recurso. Considerando que o recurso foi interposto em [Data], a presente peça é plenamente tempestiva.

2. SÍNTESE DOS FATOS

Trata-se de licitação na modalidade Pregão Eletrônico, sob o critério de julgamento de **menor preço por item**, visando a aquisição de equipamentos de informática para atender as necessidades da Câmara Municipal de Votuporanga.

Após a fase competitiva de lances, a empresa **49.608.894 Arthur Davanço Moretto** sagrou-se vencedora do(s) item(ns) em disputa, tendo apresentado a proposta economicamente mais vantajosa para a Administração Pública.

Inconformada com o resultado, a empresa Recorrente interpôs recurso administrativo pleiteando a desclassificação desta Peticionária, sustentando, em síntese, dois pontos principais:

Rua Minas Gerais, 4193 – Patrimônio Velho – Votuporanga/SP – Cep: 15500-003

Telefone: (17) 98815-1758 Email: Tuitecnologia@Gmail.Com

CNPJ 49.608.894/0001-96

- a) *Uma suposta irregularidade formal por não ter constado a Falta marca do equipamento no formulário de credenciamento/proposta inicial;*
- b) *Uma alegada desconformidade técnica, sob o argumento de que o aparelho ofertado não atenderia às especificações detalhadas no Termo de Referência (Anexo I).*

Entretanto, conforme restará demonstrado nestas contrarrazões, tais argumentos são desprovidos de fundamento jurídico e técnico, uma vez que a proposta cumpre rigorosamente o edital e o interesse público foi plenamente preservado.

3. DO DIREITO E DAS RAZÕES PARA MANUTENÇÃO DO ATO

3.1. Falta da marca na proposta de credenciamento

3.1.1. Do Princípio do Formalismo Moderado e da Instrumentalidade das Formas

A Nova Lei de Licitações (Lei nº 14.133/2021) consagra em seu art. 12, inciso III, que o desatendimento de exigências meramente formais que não comprometam a aferição da qualificação do licitante ou a exequibilidade da proposta não deve conduzir à desclassificação.

No caso em tela, esta Licitante sagrou-se vencedora na etapa de lances, oferecendo a proposta mais vantajosa para a Administração Pública. A falta de indicação da marca no sistema é falha formal e sanável, uma vez que o produto ofertado atende integralmente a todas as especificações técnicas exigidas no Termo de Referência (Anexo I).

3.1.2. Da Previsão Editalícia de Saneamento de Erros

O próprio Edital deste certame prevê expressamente a possibilidade de saneamento de falhas que não alterem a substância da proposta. O item 6.13 e o item 24.6 estabelecem que:

"A Administração poderá sanar erros ou falhas que não alterem a substância das propostas, dos documentos e sua validade jurídica, mediante despacho fundamentado, atribuindo-lhes validade e eficácia para fins de habilitação e classificação."

Portanto, a marca pode ser perfeitamente identificada e confirmada através de diligência do Pregoeiro ou na apresentação da proposta realinhada (item 5.17.4), procedimento este que não altera o objeto nem o preço ofertado.

Rua Minas Gerais, 4193 – Patrimônio Velho – Votuporanga/SP – Cep: 15500-003

Telefone: (17) 98815-1758 Email: Tuitecnologia@Gmail.Com

CNPJ 49.608.894/0001-96

3.1.3. Do Interesse Público e da Ampliação da Disputa

O item 24.1 do Edital reforça que as normas devem ser interpretadas em favor da ampliação da disputa. Desclassificar a melhor oferta por um detalhe de preenchimento de sistema, quando a empresa demonstra capacidade técnica e preço inferior, configuraria um excesso de rigorismo formal, prejudicando o erário municipal.

A jurisprudência do Tribunal de Contas da União (TCU) é pacífica no sentido de que a desclassificação de proposta com preço inferior devido a erros formais sanáveis é irregular, pois afronta o princípio da seleção da proposta mais vantajosa (Acórdão 1.211/2021-Plenário).

3.2. Desconformidade Técnica do aparelho apresentado

A alegação de que o equipamento não condiz com o pedido no edital, cumpre esclarecer que o modelo inicialmente apresentado (AOC 22B35HM23) acompanha todos os acessórios necessários para seu pleno funcionamento, incluindo o adaptador de energia e cabos de sinal, conforme especificações de fábrica. Caso a Administração identifique a necessidade de um adaptador adicional para integração com sistemas específicos, o referido item será fornecido sem custos adicionais, garantindo a funcionalidade exigida.

Ademais, primando pelo princípio da máxima competitividade e interesse público, oferece-se a alternativa de fornecimento do modelo PCFort Gamer H238F165. Este equipamento possui conectividade nativa diversificada, incluindo entradas HDMI e DisplayPort, o que dispensa o uso de adaptadores externos para conexão de vídeo, mantendo o alto desempenho de atualização de até 165Hz e tempo de resposta de 1ms exigidos para operações de alta performance.

Pontos Técnicos de Apoio:

- Modelo AOC 22B35HM23: O manual confirma que o adaptador de energia é um item incluso na caixa e que o monitor suporta conexões HDMI e Analógica (VGA). (folder em anexo)*
- Modelo PCFort Gamer H238F165: O manual destaca a presença de múltiplas entradas (HDMI, DisplayPort, USB) e a capacidade de atingir altas taxas de atualização (165Hz via DisplayPort), o que pode ser usado como argumento de superioridade técnica ou maior compatibilidade direta. (folder em anexo)*

3.2.1 Princípio do Formalismo Moderado;

A Administração deve evitar o rigor excessivo que leve à desclassificação de propostas vantajosas por falhas meramente formais ou acessórias que podem ser resolvidas sem prejuízo ao erário.

3.2.2. Saneamento de Falhas (Art. 59, Lei 14.133/2021);

*A lei permite que a Administração realize diligências para complementar informações ou corrigir defeitos que não alterem a substância da proposta. Se o monitor cumpre a função técnica e o licitante se compromete a fornecer o adaptador (ou um modelo superior como o PCFort) sem alteração de preço, o **interesse público é preservado**.*

3.2.3. Finalidade do Objeto;

Se o requisito de conectividade é atingido (seja via adaptador ou porta nativa no modelo alternativo), o objetivo técnico do edital foi satisfeito. O descumprimento só seria "insanável" se o equipamento fosse incapaz de realizar a função pretendida, independentemente de acessórios.

4.. DO PEDIDO

Diante do exposto, requer-se:

- a) O NÃO PROVIMENTO do recurso interposto pela Recorrente, mantendo-se a classificação desta Licitante como vencedora dos itens arrematados;*
- b) Caso Vossa Senhoria entenda necessário, que seja aberto prazo para saneamento da omissão, com a indicação formal da marca do produto, nos termos dos itens 6.13 e 24.6 do Edital.*

*Termos em que, pede e espera deferimento.
Votuporanga, 04 de maio de 2026*

Arthur Davanço Moretto

Manual do Monitor PCFort Gamer H238F165

Introdução

O Monitor Gamer PCFort H238F165 foi desenvolvido para oferecer desempenho superior em jogos e produtividade, com taxa de atualização de até 165Hz, tempo de resposta de 1ms e tecnologia FreeSync. Este manual fornece instruções de instalação, configuração e uso.

Especificações Técnicas

Tela

- Tipo de painel: VA
- Tamanho: 23.8"
- Resolução: 1920x1080 (Full HD)
- Ângulo de visão: 178°/178°
- Mira para jogos FPS: 5 opções
- Quantidade de cores: 16,7 milhões
- Tempo de resposta: 1 ms
- Ângulo de inclinação: ~5° a ~15°
- Filtro de luz azul: Sim
- Taxa de atualização: 165Hz (DisplayPort), 120Hz (HDMI)
- Contraste: 1000:1
- Brilho: 250 cd/m²
- FreeSync: Sim, ativação pelo menu OSD

Conectividade

- Entradas: HDMI, DisplayPort, USB, Fone, DC
- Saída de áudio: Sim
- Entrada para fones: Sim
- Suporte/base: Metal resistente, fácil montagem
- Furação VESA: 75mm

Alimentação

- Voltagem: Bivolt 12V/3A
- Consumo: 32 W
- Consumo em standby: 0,3 W

Dimensões

- Apenas monitor: 32 cm (A) x 54 cm (L) x 4 cm (P) | Peso: 2,21 kg
 - Com base: 39,8 cm (A) x 54 cm (L) x 16,1 cm (P) | Peso: 2,44 kg
-

Instalação

1. **Montagem da base:** encaixe a base metálica no suporte do monitor e fixe com os parafusos fornecidos.
 2. **Fixação VESA:** para instalação em suportes de parede ou braços articulados, utilize a furação padrão VESA 75mm.
 3. **Conexões:** conecte o cabo HDMI ou DisplayPort ao computador ou console. Para melhor desempenho, utilize DisplayPort para atingir 165Hz.
 4. **Áudio:** conecte fones de ouvido ou caixas de som na saída de áudio do monitor.
 5. **Alimentação:** conecte o adaptador de energia (12V/3A) e ligue o monitor.
-

Configuração Inicial

1. **Resolução:** configure o sistema para 1920x1080.
 2. **Taxa de atualização:** ajuste para 165Hz (DisplayPort) ou 120Hz (HDMI) nas configurações de vídeo do sistema.
 3. **FreeSync:** ative pelo menu OSD para sincronização adaptativa.
 4. **Filtro de luz azul:** habilite para reduzir fadiga ocular.
 5. **Mira FPS:** selecione uma das 5 opções disponíveis no menu OSD.
-

Menu OSD (On-Screen Display)

- **Brilho/Contraste:** ajuste conforme preferência.
 - **Modos de jogo:** escolha perfis otimizados para FPS, RTS ou uso geral.
 - **Overdrive:** habilite para resposta mais rápida em jogos competitivos.
 - **Configurações de cor:** ajuste temperatura e saturação conforme necessidade.
-

Manutenção e Cuidados

- Limpe a tela com pano macio e seco.
- Não utilize produtos químicos abrasivos.
- Evite exposição direta ao sol ou calor excessivo.
- Desconecte da energia em longos períodos sem uso.

Garantia

O Monitor PCFort Gamer H238F165 possui garantia de fábrica conforme legislação vigente. Guarde a nota fiscal e consulte o suporte PCFort em caso de necessidade.

Suporte Técnico

Para dúvidas ou assistência, entre em contato com o suporte PCFort ou o revendedor autorizado.

AOC



LCD Monitor User Manual

22B35HM23

www.aoc.com

©2024 AOC.All Rights Reserved.

Version: A00

HDMI[®]
HIGH-DEFINITION MULTIMEDIA INTERFACE

Safety.....	1
National Conventions	1
Power.....	2
Installation	3
Cleaning.....	4
Other.....	5
Setup	6
Contents in Box.....	6
Stand & Base Setup	7
Adjusting Viewing Angle	8
Connecting the Monitor	9
Wall Mounting	10
Adaptive-Sync function.....	12
Adjusting	13
Hotkeys.....	13
OSD Setting.....	15
Luminance.....	16
Image Setup	17
Color Setup	18
Picture Boost.....	19
OSD Setup	20
Game Setting	21
Extra.....	22
Exit.....	23
LED Indicator	24
Troubleshoot.....	25
Specification	26
General Specification.....	26
Preset Display Modes	27
Pin Assignments.....	28
Plug and Play	29

Safety

National Conventions

The following subsections describe national conventions used in this document.

Notes, Cautions, and Warnings

Throughout this guide, blocks of text may be accompanied by an icon and printed in bold type or in italic type. These blocks are notes, cautions, and warnings, and they are used as follows:



NOTE: A NOTE indicates important information that helps you make better use of your computer system.





CAUTION: A CAUTION indicates either potential damage to hardware or loss of data and tells you how to avoid the problem.



WARNING: A WARNING indicates the potential for bodily harm and tells you how to avoid the problem. Some warnings may appear in alternate formats and may be unaccompanied by an icon. In such cases, the specific presentation of the warning is mandated by regulatory authority.

Power

 The monitor should be operated only from the type of power source indicated on the label. If you are not sure of the type of power supplied to your home, consult your dealer or local power company.

 Unplug the unit during a lightning storm or when it will not be used for long periods of time. This will protect the monitor from damage due to power surges.

 Do not overload power strips and extension cords. Overloading can result in fire or electric shock.

 To ensure satisfactory operation, use the monitor only with UL listed computers which have appropriate configured receptacles marked between 100-240V AC, Min. 5A.

 The wall socket shall be installed near the equipment and shall be easily accessible.

 For use only with the attached power adapter.

Manufacturers: Ten Pao Industrial Co., Ltd.

Model: S025ANP1900131

Manufacturers: TPV ELECTRONICS(FUJIAN)CO.,LTD.

Model: ADPC1925EX

Installation

! Do not place the monitor on an unstable cart, stand, tripod, bracket, or table. If the monitor falls, it can injure a person and cause serious damage to this product. Use only a cart, stand, tripod, bracket, or table recommended by the manufacturer or sold with this product. Follow the manufacturer's instructions when installing the product and use mounting accessories recommended by the manufacturer. A product and cart combination should be moved with care.

! Never push any object into the slot on the monitor cabinet. It could damage circuit parts causing a fire or electric shock. Never spill liquids on the monitor.

! Do not place the front of the product on the floor.

! If you mount the monitor on a wall or shelf, use a mounting kit approved by the manufacturer and follow the kit instructions.

! Leave some space around the monitor as shown below. Otherwise, air-circulation may be inadequate hence overheating may cause a fire or damage to the monitor.

! To avoid potential damage, for example the panel peeling from the bezel, ensure that the monitor does not tilt downward by more than -5 degrees. If the -5 degree downward tilt angle maximum is exceeded, the monitor damage will not be covered under warranty.

See below the recommended ventilation areas around the monitor when the monitor is installed on the wall or on the stand:

Installed with stand

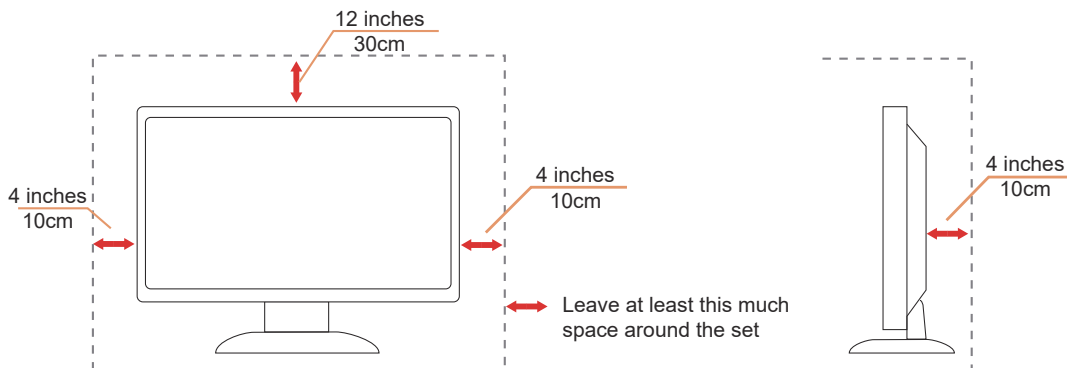

Cleaning

! Clean the cabinet regularly with cloth. You can use soft-detergent to wipe out the stain, instead of strong-detergent which will cauterize the product cabinet.

! When cleaning, make sure no detergent is leaked into the product. The cleaning cloth should not be too rough as it will scratch the screen surface.





! Please disconnect the power cord before cleaning the product.

Other

 If the product is emitting a strange smell, sound or smoke, disconnect the power plug IMMEDIATELY and contact a Service Center.

 Make sure that the ventilating openings are not blocked by a table or curtain.

 Do not engage the LCD monitor in severe vibration or high impact conditions during operation.

 Do not knock or drop the monitor during operation or transportation.

 The power cords shall be safety approved. For Germany, it shall be H03VV-F, 3G, 0.75 mm², or better. For other countries, the suitable types shall be used accordingly.

 Excessive sound pressure from earphones and headphones can cause hearing loss. Adjustment of the equalizer to maximum increases the earphones and headphones output voltage and therefore the sound pressure level.

Setup

Contents in Box

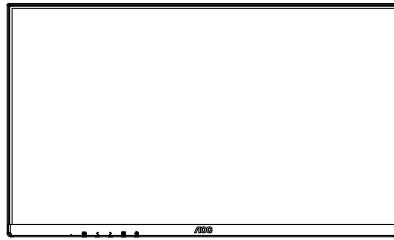

Monitor

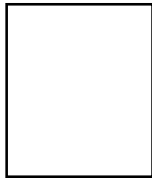

Quick Start Guide



Warranty card

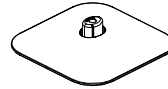

Base

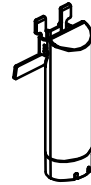

Stand



Power Cable



Adapter



HDMI Cable



VGA Cable

*Not all signal cables will be provided for all countries and regions. Please check with the local dealer or AOC branch office for confirmation.

Stand & Base Setup

Please setup or remove the base following the steps as below.

Setup:

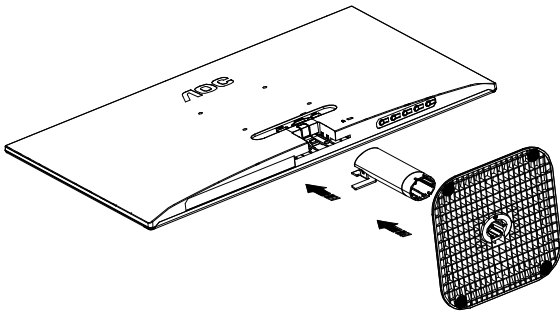

Remove:

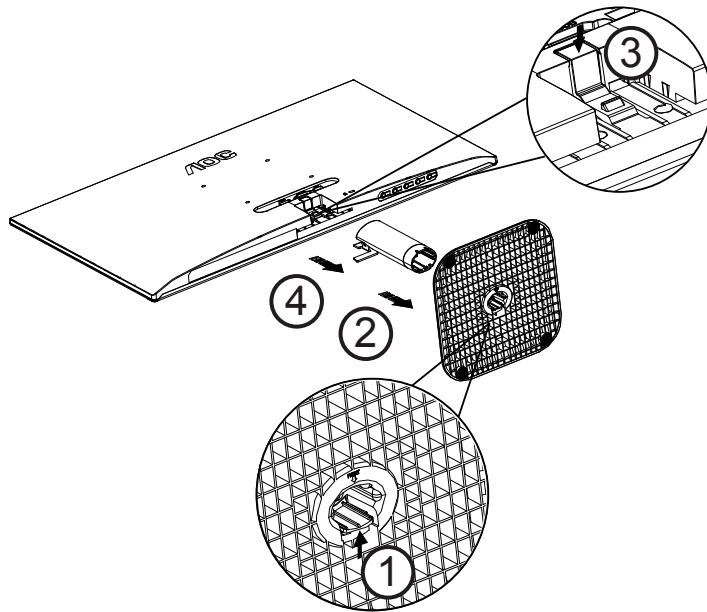

Adjusting Viewing Angle

To achieve the best viewing experience, it is recommended that the user can make sure they are able to look at their whole face on the screen, then adjust the monitor's angle based on personal preference.

Hold the stand so you will not topple the monitor when you change the monitor's angle.

You are able to adjust the monitor as below:

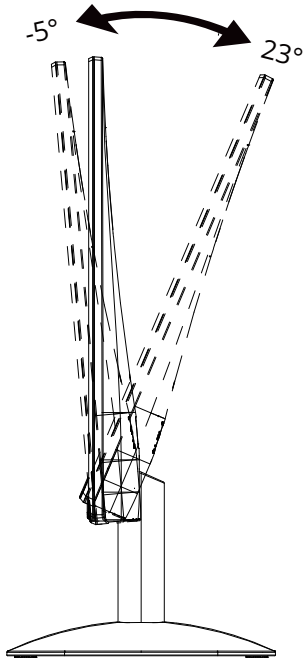

NOTE:

Do not touch the LCD screen when you change the angle. It may cause damage or break the LCD screen.

WARNING:

1. To avoid potential screen damage, such as panel peeling, ensure that the monitor does not tilt downward by more than -5 degrees.
2. Do not press the screen while adjusting the angle of the monitor. Grasp only the bezel.

Connecting the Monitor

Cable Connections In Back of Monitor:

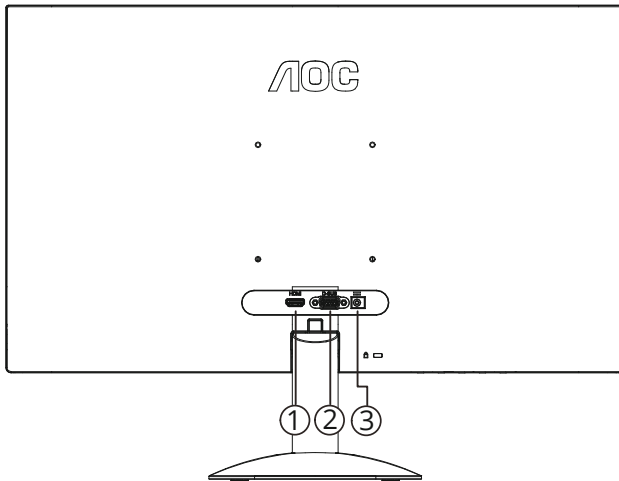

1. HDMI
2. Analog (D-Sub 15-Pin VGA cable)
3. Power

Connect to PC

1. Connect the power cord to the back of the display firmly.
2. Turn off your computer and unplug its power cable.
3. Connect the display signal cable to the video connector on the back of your computer.
4. Plug the power cord of your computer and your display into a nearby outlet.
5. Turn on your computer and display.

If your monitor displays an image, installation is complete. If it does not display an image, please refer to Troubleshoot.

To protect equipment, always turn off the PC and LCD monitor before connecting.

Wall Mounting

Preparing to Install An Optional Wall Mounting Arm.

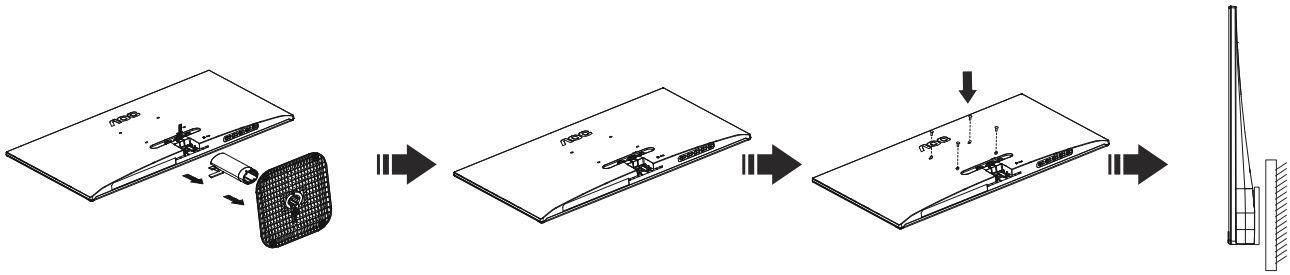

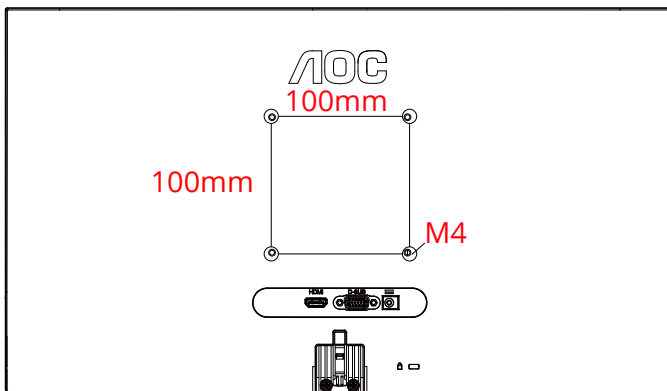

This monitor can be attached to a wall mounting arm you purchase separately. Disconnect power before this procedure. Follow these steps:

1. Remove the base.
2. Follow the manufacturer's instructions to assemble the wall mounting arm.
3. Place the wall mounting arm onto the back of the monitor. Line up the holes of the arm with the holes in the back of the monitor.
4. Insert the 4 screws into the holes and tighten.
5. Reconnect the cables. Refer to the user's manual that came with the optional wall mounting arm for instructions on attaching it to the wall.

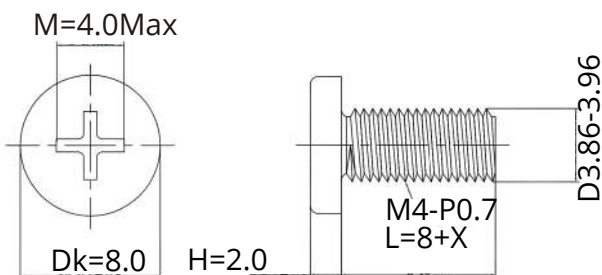

Specification of wall hanger screws: M4*(8+X)mm, (X=Thickness of Wall mount bracket)



 Noted: VESA mounting screw holes are not available for all models, please check with the dealer or official department of AOC. Always contact manufacturer for wall-mount installation.

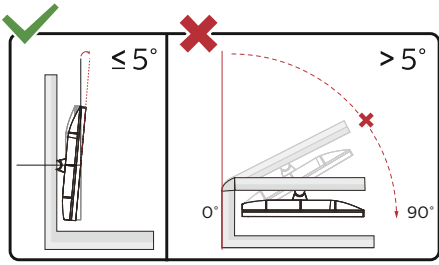

* Display design may differ from those illustrated.

WARNING:

1. To avoid potential screen damage, such as panel peeling, ensure that the monitor does not tilt downward by more than -5 degrees.
2. Do not press the screen while adjusting the angle of the monitor. Grasp only the bezel.

Adaptive-Sync function

1. Adaptive-Sync function works with HDMI
2. Compatible Graphics Card: Recommended list is as below, also could be checked by visiting www.AMD.com

Graphics Cards

- Radeon™ RX Vega series
- Radeon™ RX 500 series
- Radeon™ RX 400 series
- Radeon™ R9/R7 300 series (R9 370/X, R7 370/X, R7 265 except)
- Radeon™ Pro Duo (2016)
- Radeon™ R9 Nano series
- Radeon™ R9 Fury series
- Radeon™ R9/R7 200 series (R9 270/X, R9 280/X except)

Processors

- AMD Ryzen™ 7 2700U
- AMD Ryzen™ 5 2500U
- AMD Ryzen™ 5 2400G
- AMD Ryzen™ 3 2300U
- AMD Ryzen™ 3 2200G
- AMD PRO A12-9800
- AMD PRO A12-9800E
- AMD PRO A10-9700
- AMD PRO A10-9700E
- AMD PRO A8-9600
- AMD PRO A6-9500
- AMD PRO A6-9500E
- AMD PRO A12-8870
- AMD PRO A12-8870E
- AMD PRO A10-8770
- AMD PRO A10-8770E
- AMD PRO A10-8750B
- AMD PRO A8-8650B
- AMD PRO A6-8570
- AMD PRO A6-8570E
- AMD PRO A4-8350B
- AMD A10-7890K
- AMD A10-7870K
- AMD A10-7850K
- AMD A10-7800
- AMD A10-7700K
- AMD A8-7670K
- AMD A8-7650K
- AMD A8-7600
- AMD A6-7400K

Adjusting

Hotkeys

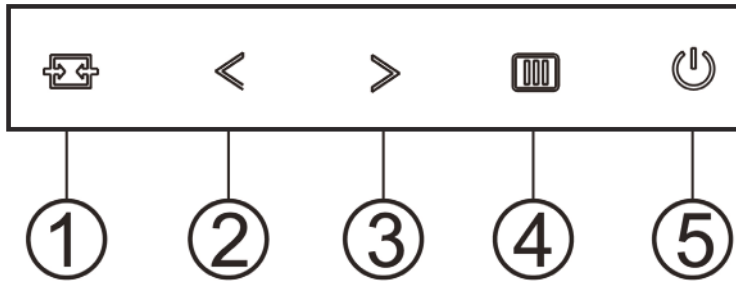

1	Source/Auto/Exit
2	Clear Vision/<
3	Image ratio/>
4	Menu/Enter
5	Power

Menu/Enter

When there is no OSD, Press to display the OSD or confirm the selection.

Power

Press the Power button to turn on the monitor.

Image ratio

When there is no OSD, Press > hotkey to active image ratio , Press < or > to adjust 4:3 or wide. (If the product screen size is 4:3 or input signal resolution is wide format, the hot key is disable to adjust).

Source/Auto/Exit

When the OSD is closed, press Source/Auto/Exit button will be Source hot key function.

When the OSD is closed, press Source/Auto/Exit button continuously about 2 second to do auto configure (Only for the models with D-Sub).

Clear Vision

1. When there is no OSD, Press the "<" button to activate Clear Vision.
2. Use the ">" or ">" buttons to select between weak, medium, strong, or off settings. Default setting is always "off".

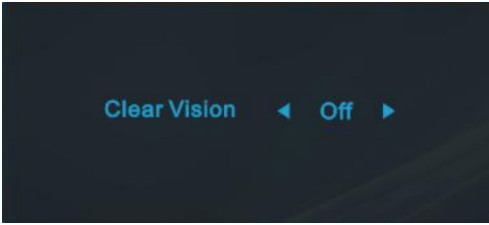

3. Press and hold "<" button for 5 seconds to activate the Clear Vision Demo, and a message of "Clear Vision Demo: on" will be display on the screen for a duration of 5 seconds. Press Menu or Exit button, the message will disappear. Press and hold "<" button for 5 seconds again, Clear Vision Demo will be off.

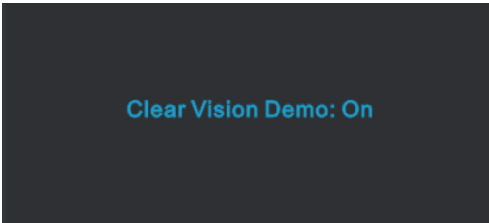







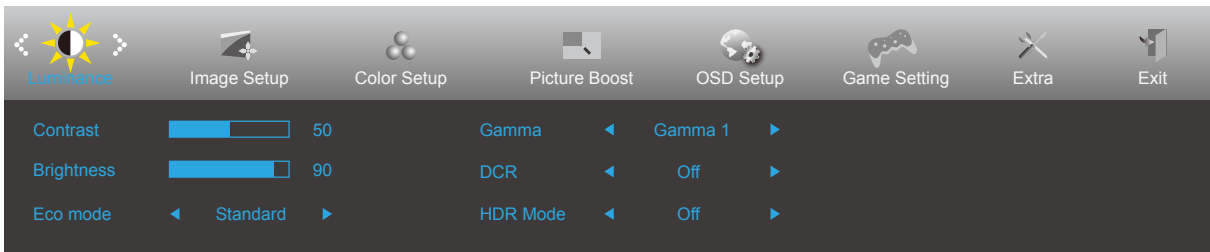

Clear Vision function provides the best image viewing experience by converting low resolution and blurry images into clear and vivid images.

OSD Setting

Basic and simple instruction on the control keys.









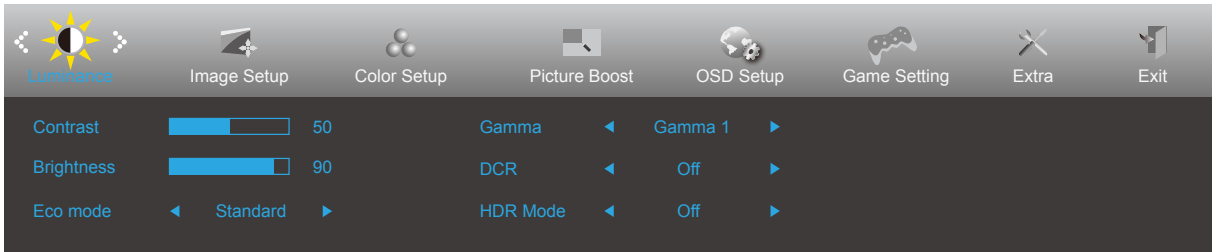

- 1). Press the  Menu-button to activate the OSD window.
- 2). Press < Left or > Right to navigate through the functions. Once the desired function is highlighted, press the  Menu-button to activate it, press < Left or > Right to navigate through the sub-menu functions. Once the desired function is highlighted, press  Menu-button to activate it.
- 3). Press < Left or > to change the settings of the selected function. Press  to exit. If you want to adjust any other function, repeat steps 2-3.
- 4). OSD Lock Function: To lock the OSD, press and hold the  Menu-button while the monitor is off and then press  power button to turn the monitor on. To un-lock the OSD - press and hold the  Menu-button while the monitor is off and then press  power button to turn the monitor on.

Notes:

- 1). If the product has only one signal input, the item of "Input Select" is unable to be adjusted.
- 2). ECO modes (except Standard mode), DCR, DCB mode and Picture Boost, for these four states that only one state can exist.

Luminance





	Contrast	0-100		Contrast from Digital-register.
	Brightness	0-100		Backlight Adjustment.
	Eco mode	Standard	<input checked="" type="checkbox"/>	Standard Mode.
		Text		Text Mode.
		Internet		Internet Mode.
		Game		Game Mode.
		Movie		Movie Mode.
		Sports		Sports Mode.
		Reading		Reading Mode.
	Gamma	Gamma1	Adjust to Gamma 1.	
		Gamma2	Adjust to Gamma 2.	
		Gamma3	Adjust to Gamma 3.	
	DCR	On		Enable dynamic contrast ratio.
		Off		Disable dynamic contrast ratio.
	HDR Mode	Off	Select HDR Mode.	
HDR Picture				
HDR Movie				
HDR Game				

Note:

When "HDR Mode" is set to "non-off", the items "Contrast", "Eco mode ", "Gamma" cannot be adjusted.

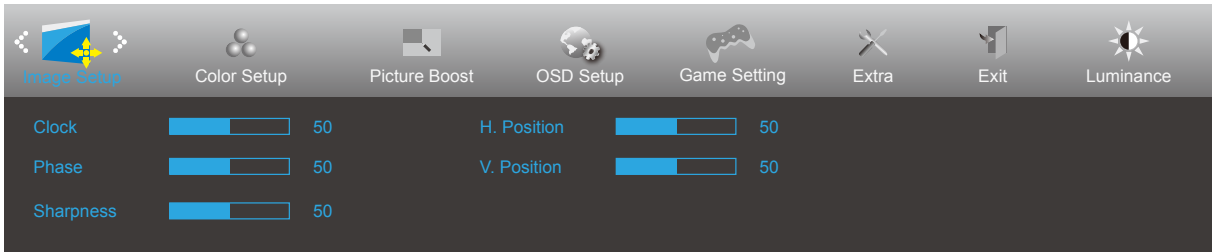
Image Setup



	Clock	0-100	Adjust picture Clock to reduce Vertical-Line noise.
	Phase	0-100	Adjust Picture Phase to reduce Horizontal-Line noise
	Sharpness	0-100	Adjust picture sharpness
	H. Position	0-100	Adjust the horizontal position of the picture.
	V. Position	0-100	Adjust the vertical position of the picture.

Color Setup

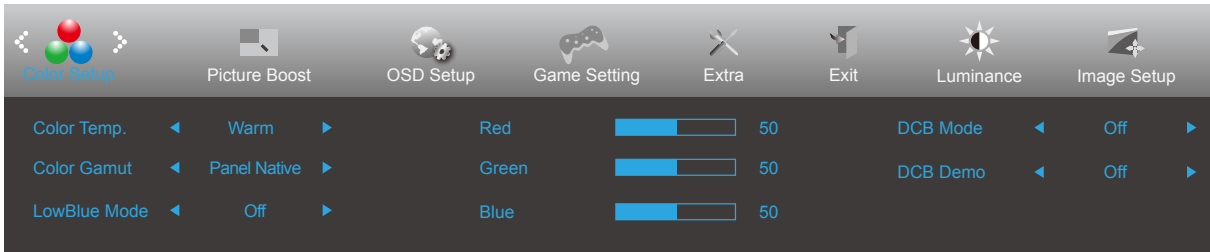



	Color Temp.	Warm	Recall Warm Color Temperature from EEPROM.
		Normal	Recall Normal Color Temperature from EEPROM.
		Cool	Recall Cool Color Temperature from EEPROM.
		User	Restore Color Temperature from EEPROM.
	Color Gamut	Panel Native	Recall Panel Native Color Temperature from EEPROM.
		sRGB	Recall sRGB Color Temperature from EEPROM.
	LowBlue Mode	Reading / Office / Internet / Multimedia / Off	Decrease blue light wave by controlling color temperature.
	Red	0-100	Red gain from Digital-register.
	Green	0-100	Green gain from Digital-register.
	Blue	0-100	Blue gain from Digital-register.
	DCB Mode	Off	Disable DCB Mode.
		Full Enhance	Disable or Enable Full Enhance Mode
		Nature Skin	Disable or Enable Nature Skin Mode
		Green Field	Disable or Enable Green Field Mode
Sky-blue		Disable or Enable Sky-blue Mode	
AutoDetect		Disable or Enable AutoDetect Mode	
DCB Demo	On or Off	Disable or Enable Demo	

Note:

When "HDR Mode" under "Luminance" is set to "non-off", all items under "Color Setup" cannot be adjusted.

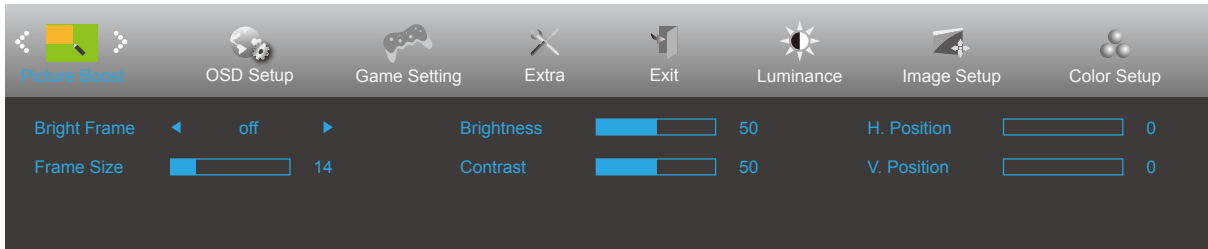
Picture Boost



	Bright Frame	On or Off	Disable or Enable Bright Frame
	Frame Size	14-100	Adjust Frame Size
	Brightness	0-100	Adjust Frame Brightness
	Contrast	0-100	Adjust Frame Contrast
	H. position	0-100	Adjust Frame horizontal Position
	V. position	0-100	Adjust Frame vertical Position

Note:

Adjust the brightness, contrast, and position of the Bright Frame for better viewing experience.

When "HDR Mode" under "Luminance" is set to "non-off", all items under "Picture Boost" cannot be adjusted.

OSD Setup

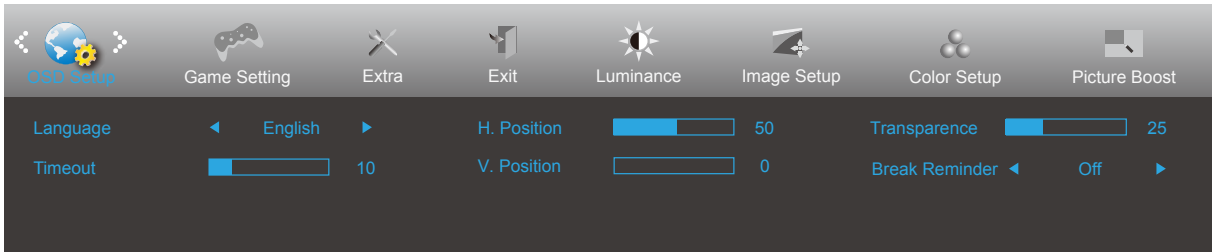

	Language		Select the OSD language
	Timeout	5-120	Adjust the OSD Timeout
	H. Position	0-100	Adjust the horizontal position of OSD
	V. Position	0-100	Adjust the vertical position of OSD
	Transparence	0-100	Adjust the transparence of OSD
	Break Reminder	on or off	Break reminder if the user continuously works for more than 1hrs

Game Setting

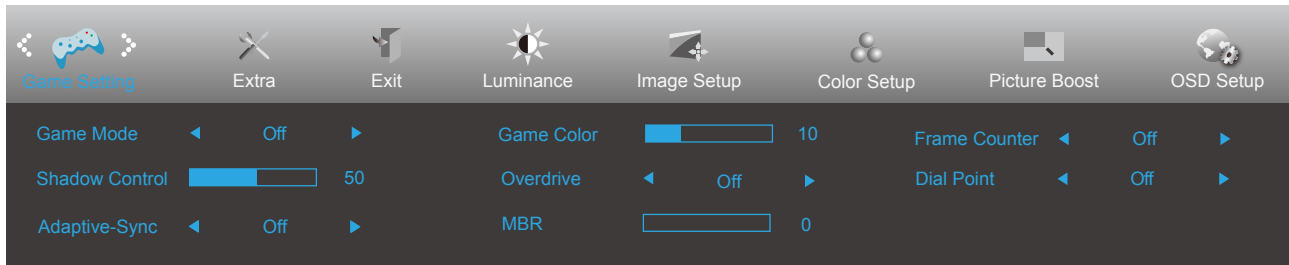



	Game Mode	Off	No optimization by Smart image game
		FPS	For playing FPS (First Person Shooters) games. Improves black level in dark theme.
		RTS	For playing RTS (Real Time Strategy). Improves the image quality.
		Racing	For playing Racing games, Provides fastest response time and high color saturation.
		Gamer 1	User's preference settings saved as Gamer 1.
		Gamer 2	User's preference settings saved as Gamer 2.
		Gamer 3	User's preference settings saved as Gamer 3.
	Shadow Control	0-100	Shadow Control Default is 50, then end-user can adjust from 50 to 100 or 0 to increase/decrease contrast for clear picture. 1. If picture is too dark to be saw the detail clearly, adjusting from 50 to100 for clear picture. 2. If picture is too white to be saw the detail clearly, adjusting from 50 to0 for clear picture
	Adaptive-Sync	On or Off	Disable or Enable Adaptive-Sync. Adaptive-Sync Run Reminder: When the Adaptive-Sync feature is enabled, there may be flashing in some game environments.
	Game Color	0-20	Game Color will provide 0-20 level for adjusting saturation to get better picture.
	Overdrive	Off	Adjust the response time.
		Weak	
		Medium	
Strong			
Boost			
MBR	0 ~ 20	Adjust the Motion Blur Reduction.	
Frame Counter	Off / Right-up / Right-Down / Left-Down / Left-Up	Display V frequency on the corner selected	
Dial Point	On or Off	The“Dial Point”function places an aiming indicator in the center of screen for helping gamers to play First Person Shooter (FPS) games with an accurate and precise aiming.	

Note:

When “HDR Mode” under “Luminance” is set to “non-off”, the items “Game Mode”, “Shadow Control”, “Game Color” cannot be adjusted.

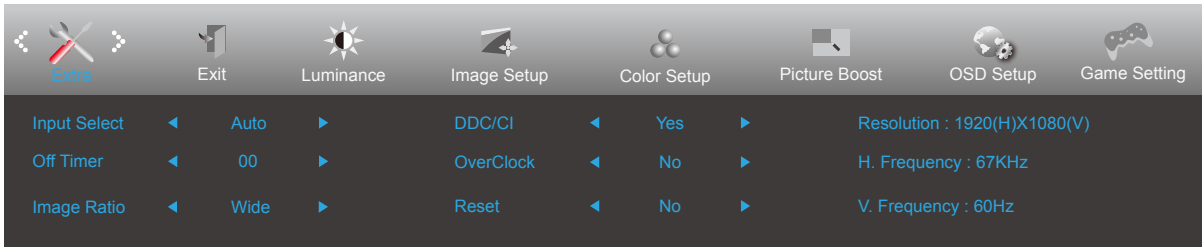
Extra



	Input Select		Select Input Signal Source.
	Off Timer	0-24hrs	Select DC off time.
	Image Ratio	Wide	Select image ratio for display.
		4:3	
	DDC/CI	Yes or No	Turn ON/OFF DDC/CI Support.
	OverClock	On or Off	Disable or Enable Over Clock.
	Reset	Yes or No	Reset the menu to default.

Exit

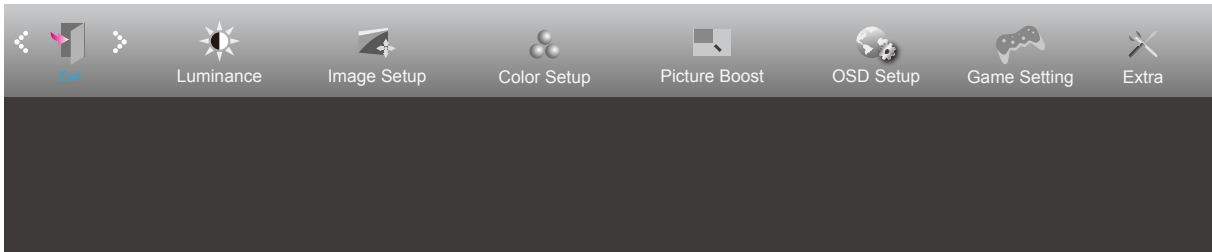

	Exit		Exit the main OSD
---	------	--	-------------------

LED Indicator

Status	LED Color
Full Power Mode	White
Power Saving	Orange

Troubleshoot

Problem & Question	Possible Solutions
Power LED Is Not ON	Make sure the power button is ON and the Power Cord is properly connected to a grounded power outlet and to the monitor.
No image on the screen	<ul style="list-style-type: none"> • Is the power cord connected properly? Check the power cord connection and power supply. • Is the video cable connected correctly? (Connected using the VGA cable) Check the VGA cable connection. (Connected using the HDMI cable) Check the HDMI cable connection. * VGA/HDMI input is not available on every model. • If the power is on, reboot the computer to see the initial screen (the login screen.) If the initial screen (the login screen) appears, boot the computer in the applicable mode (the safe mode for Windows 7/8/10) and then change the frequency of the video card. (Refer to the Setting the Optimal Resolution) If the initial screen (the login screen) does not appear, contact the Service Center or your dealer. • Can you see "Input Not Supported" on the screen? You can see this message when the signal from the video card exceeds the maximum resolution and frequency that the monitor can handle properly. Adjust the maximum resolution and frequency that the monitor can handle properly. • Make sure the AOC Monitor Drivers are installed.
Picture Is Fuzzy & Has Ghosting Shadowing Problem	Adjust the Contrast and Brightness Controls. Press hot-key (AUTO) to auto-adjust. Make sure you are not using an extension cable or switch box. We recommend plugging the monitor directly to the video card output connector on the back.
Picture Bounces, Flickers Or Wave Pattern Appears In The Picture	Move electrical devices that may cause electrical interference as far away from the monitor as possible. Use the maximum refresh rate your monitor is capable of at the resolution you are using.
Monitor Is Stuck In Active Off-Mode"	The Computer Power Switch should be in the ON position. The Computer Video Card should be snugly fitted in its slot. Make sure the monitor's video cable is properly connected to the computer. Inspect the monitor's video cable and make sure no pin is bent. Make sure your computer is operational by hitting the CAPS LOCK key on the keyboard while observing the CAPS LOCK LED. The LED should either turn ON or OFF after hitting the CAPS LOCK key.
Missing one of the primary colors (RED, GREEN, or BLUE)	Inspect the monitor's video cable and make sure that no pin is damaged. Make sure the monitor's video cable is properly connected to the computer.
Screen image is not centered or sized properly	Adjust H-Position and V-Position or press hot-key (AUTO).
Picture has color defects (white does not look white)	Adjust RGB color or select desired color temperature.
Horizontal or vertical disturbances on the screen	Use Windows 7/8/10 shut-down mode to adjust CLOCK and FOCUS. Press hot-key (AUTO) to auto-adjust.
Regulation & Service	Please refer to Regulation & Service Information which is in the CD manual or www.aoc.com (to find the model you purchase in your country and to find Regulation & Service Information in Support page).

Specification

General Specification

Panel	Model name	22B35HM23		
	Driving system	TFT Color LCD		
	Viewable Image Size	54.5cm diagonal(21.5" Wide Screen)		
	Pixel pitch	0.2493 (H)mm x 0.241 (V) mm		
	Display Color	16.7M		
Others	Horizontal scan range	30k-85kHz(D-SUB)		
		30k-140kHz(HDMI)		
	Horizontal scan Size(Maximum)	478.656mm		
	Vertical scan range	48-75Hz(D-SUB)		
		48-120Hz(HDMI)		
	Vertical Scan Size(Maximum)	260.28mm		
	Optimal preset resolution	1920x1080@60Hz		
	Max resolution	1920x1080@75Hz(D-SUB)		
		1920x1080@120Hz(HDMI) ^[1]		
	Plug & Play	VESA DDC2B/CI		
Power Source	19V = 1.31A			
Power Consumption	Typical(default brightness and contrast)	16W		
	Max.(brightness = 100, contrast =100)	≤ 24W		
	Standby mode	≤0.3W		
Physical Characteristics	Connector Type	HDMI/D-Sub		
	Signal Cable Type	Detachable		
Environmental	Temperature	Operating	0°C~ 40°C	
		Non-Operating	-25°C~ 55°C	
	Humidity	Operating	10%~85% (Non-Condensing)	
		Non-Operating	5%~93% (Non-Condensing)	
	Altitude	Operating	0m~5000m (0ft~16404ft)	
		Non-Operating	0m~12192m (0ft~40000ft)	

*[1]:Overclocking is achieved when resolution is at 1920x1080@120Hz. If any display error occurs during overclocking,please adjust the refresh rate to 100Hz.

Preset Display Modes

STANDARD	RESOLUTION(+/-1Hz)	HORIZONTAL FREQUENCY(kHz)	VERTICAL FREQUENCY(Hz)
VGA	640x480@60Hz	31.469	59.94
	640x480@72Hz	37.861	72.809
	640x480@75Hz	37.5	75
MAC MODES VGA	640x480@67Hz	35	66.667
IBM MODE	720x400@70Hz	31.469	70.087
SVGA	800x600@56Hz	35.156	56.25
	800x600@60Hz	37.879	60.317
	800x600@72Hz	48.077	72.188
	800x600@75Hz	46.875	75
MAC MODES SVGA	832x624@75Hz	49.725	74.5
XGA	1024x768@60Hz	48.363	60.004
	1024x768@70Hz	56.476	70.069
	1024x768@75Hz	60.023	75.029
SXGA	1280x1024@60Hz	63.981	60.02
	1280x1024@75Hz	79.976	75.025
WSXG	1280x720@60Hz	45	60
	1280x960@60Hz	60	60
WXGA+	1440x900@60Hz	55.935	59.876
WSXGA+	1680x1050@60Hz	65.29	59.954
FHD	1920x1080@60Hz	67.5	60
	1920x1080@75Hz	83.9	75
	1920x1080@100Hz	110.000	100.000
	1920x1080@120Hz	135.0	120.00

Note: According to the VESA standard, there may be a certain error (+/-1Hz) when calculating the refresh rate (field frequency) of different operating systems and graphics cards. In order to improve compatibility, the nominal refresh rate of this product has been rounded off. Please refer to the actual product.

Pin Assignments

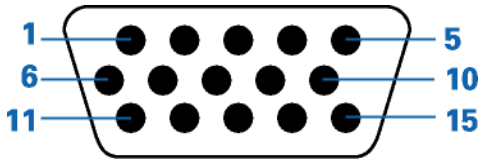

15-Pin Color Display Signal Cable

Pin No.	Signal Name	Pin No.	Signal Name
1.	Video-Red	9	+5V
2.	Video-Green	10	Ground
3.	Video-Blue	11	N.C.
4.	N.C.	12	DDC-Serial data
5.	Detect Cable	13	H-sync
6.	GND-R	14	V-sync
7.	GND-G	15	DDC-Serial clock
8.	GND-B		



19-Pin Color Display Signal Cable

Pin No.	Signal Name	Pin No.	Signal Name	Pin No.	Signal Name
1.	TMDS Data 2+	9.	TMDS Data 0-	17.	DDC/CEC Ground
2.	TMDS Data 2 Shield	10.	TMDS Clock +	18.	+5V Power
3.	TMDS Data 2-	11.	TMDS Clock Shield	19.	Hot Plug Detect
4.	TMDS Data 1+	12.	TMDS Clock-		
5.	TMDS Data 1Shield	13.	CEC		
6.	TMDS Data 1-	14.	Reserved (N.C. on device)		
7.	TMDS Data 0+	15.	SCL		
8.	TMDS Data 0 Shield	16.	SDA		

*** Only for certain models**

Plug and Play

Plug & Play DDC2B Feature

This monitor is equipped with VESA DDC2B capabilities according to the VESA DDC STANDARD. It allows the monitor to inform the host system of its identity and, depending on the level of DDC used, communicate additional information about its display capabilities.

The DDC2B is a bi-directional data channel based on the I2C protocol. The host can request EDID information over the DDC2B channel.